

MIXPAC™ A-System



2-COMPONENT INDUSTRY
SOLUTIONS



INDUSTRY



OVERVIEW

MIXPAC™ A-SYSTEM

50/75 ML INDUSTRIAL SET

ACCESSORIES

ACCESSORIES

	ID	Article
	101651	BRT 205-10
	102274	IOT 406-15
	102277	IOT 506-15
	102356 102357	LA 05-00 LA 06-08

OUTLET TIP

-  Tapered Tip (S)
-  Straight Tip (D)
-  Luer Slip Tip (L)
-  Stepped Tip (T)

MIXER



50 mL

CARTRIDGE

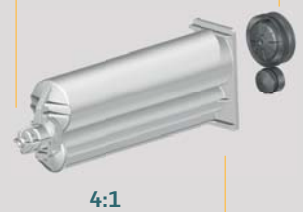
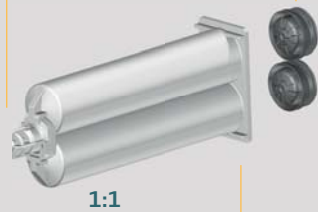

DISPENSER



PISTON RETENTION PLATE



Ratio	ID	Article
1:1/2:1	103213	PR 050-01-02 
4:1/10:1	103214	PR 050-04-10 



● MAHX (Helix)

75 mL



10:1



1:1



● TS408

CARTRIDGE SET

50/75 ML INDUSTRIAL SET



CARTRIDGE ASSEMBLY 50/75 ML

Cap preassembled
Colors: ○





Pistons Colors: ○ ●

Cartridge
Colors: Ⓝ ○ ● ⊕



Ratio Set/ Volume	ID	Article	Cartridges Material/ Color	Piston Material/Type	O-ring	Units/ Box	Mixer Technology	Matching Dispenser
1:1 50 mL	110507	AA 050-01-10-03	PP/○	HDPE, solid piston	EPDM	1250	MAH ○ MAQ ●	DMA ● DP ●
	116606	AA 050-01-10-05	PP/⊕	HDPE, solid piston	EPDM	1250	MAH ○ MAQ ●	DMA ● DP ●
	154840	AA 050-01-10-33	PP/○	HDPE, AirFT	–	1250	MAH ○ MAQ ●	DMA ● DP ●
	154826	AA 050-01-10-34	PP/○	HDPE, AirFT	EPDM	1250	MAH ○ MAQ ●	DMA ● DP ●
	154841	AA 050-01-30-33	PA/○	HDPE, AirFT	–	1250	MAH ○ MAQ ●	DMA ● DP ●
	154852	AA 050-01-30-37	PA/●	HDPE, AirFT	–	1250	MAH ○ MAQ ●	DMA ● DP ●
1:1 75 mL	116420	AA 075-01-10-02	PP/○	HDPE, solid piston	EPDM	625	MAH ○ MAQ ●	DMA ● DP ●
	154874	AA 075-01-10-33	PP/○	HDPE, AirFT	–	625	MAH ○ MAQ ●	DMA ● DP ●
	154876	AA 075-01-10-34	PP/○	HDPE, AirFT	EPDM	625	MAH ○ MAQ ●	DMA ● DP ●
2:1 50 mL	111374	AA 050-02-10-03	PP/○	HDPE, solid piston	EPDM	1250	MAH ○ MAQ ●	DMA ● DP ●
	154690	AA 050-02-10-33	PP/○	HDPE, AirFT	–	1250	MAH ○ MAQ ●	DMA ● DP ●
	154644	AA 050-02-10-34	PP/○	HDPE, AirFT	EPDM	1250	MAH ○ MAQ ●	DMA ● DP ●
4:1 50 mL	116417	AA 050-04-10-01	PP/○	A-piston, PA, self-venting lip seal; B-piston, HDPE, solid piston with O-ring	EPDM	1250	MAHX ● MAQ ●	DMA ● DP ●
	116676	AA 050-04-10-03	PP/○	HDPE, solid piston	EPDM	1250	MAHX ● MAQ ●	DMA ● DP ●
	158047	AA 050-04-30-02	PA/Ⓝ	A-piston, PA, self-venting lip seal; B-piston, PA, solid piston with O-ring	EPDM	1250	MAHX ● MAQ ●	DMA ● DP ●
10:1 50 mL	116418	AA 050-10-10-01	PP/○	A-piston, PP, self-venting lip seal; B-piston, HDPE, solid piston with O-ring	–	1250	MAHX ● MAQ ●	DMA ● DP ●
	116675	AA 050-10-10-02	PP/○	HDPE, solid piston	EPDM	1250	MAHX ● MAQ ●	DMA ● DP ●
	116917	AA 050-10-10-03	PP/○	A-piston, PP, self-venting lip seal; B-piston, HDPE, solid piston with O-ring	EPDM	1250	MAHX ● MAQ ●	DMA ● DP ●
	167303	AA 050-10-20-03	PBT/Ⓝ	A-piston, PA, self-venting lip seal; B-piston, PA, solid piston with O-ring	–	1250	MAHX ● MAQ ●	DMA ● DP ●
	158053	AA 050-10-30-02	PA/○	A-piston, PA, self-venting lip seal; B-piston, PA, solid piston with O-ring	EPDM	1250	MAHX ● MAQ ●	DMA ● DP ●

MATCHING MIXERS

	ID	Article	Number of Elements	Inner Diameter Ø mm/inch	Waste Volume (mL)	Units/Box	Outlet Tip				Accessories								
							Stepped Tip (T)	Straight Tip (D)	Luer Slip Tip (L)	Tapered Tip (S)	BRT 205-10	IOT 406-15	IOT 506-15	LA 05-00	LA 06-08				
1:1/2:1 MAH 	102361	MAH 03-07S	7	3.0/0.118	0.24	15000				✓									
	102362	MAH 03-13S	13	3.0/0.118	0.36	12000				✓									
	102364	MAH 03-17S	17	3.0/0.118	0.34	10000				✓									
	102366	MAH 04-13S	13	4.0/0.157	0.60	10000				✓									
	102368	MAH 04-17S	17	4.0/0.157	0.75	7500				✓									
	102369	MAH 05-07T	7	5.4/0.213	0.80	10000	✓											✓	
	102370	MAH 05-13D	13	5.4/0.213	1.36	7000		✓			✓		✓						
	102371	MAH 05-13T	13	5.4/0.213	1.36	6500	✓											✓	
	102360	MAH 0517-0413T	17 + 13	5.4/0.213 4.0/0.157	2.07	4000	✓												
	102372	MAH 05-17T	17	5.4/0.213	1.68	4000	✓												✓
	102373	MAH 05-21T	21	5.4/0.213	2.01	3000	✓												✓
	102377	MAH 06-12T	12	6.3/0.248	2.08	4500	✓												✓
	102378	MAH 06-17T	17	6.3/0.248	2.94	3000	✓												✓
	102379	MAH 06-21L	21	6.3/0.248	3.33	4000			✓										
	102380	MAH 06-21T	21	6.3/0.248	3.57	2500	✓												✓
4:1/10:1 MAHX 	102535	MAHX04-17S	17	4.0/0.157	0.75	7500				✓									
	102536	MAHX05-17T	17	5.4/0.213	1.68	4000	✓											✓	
1:1/2:1/4:1/10:1 MAQ 	300028	MAQ 05-16L	16	5.3/0.209	1.30	5000			✓										
	300026	MAQ 05-24L	24	5.3/0.209	1.90	3000			✓										
	300319	MAQ 05-24L-12	24	5.3/0.209	1.90	3000			✓										
	300391	MAQ 05-16L-12	16	5.3/0.209	1.30	5000			✓										
	Color	300405	MAQ 05-16L-13	16	5.3/0.209	1.30	5000			✓									

* different color

MATCHING DISPENSERS

	ID	Article	Flange	Ratio					Force (kN)
			A	1:1	2:1	4:1	10:1		
DMA dispenser manual 	101875	DMA 51-00-10	✓	✓	✓				1.2
	101883	DMA 54-00-10	✓	✓	✓	✓			1.2
	112790	DMA 59-00-10	✓	✓	✓		✓		1.2
	111746	DMA 75-00-10	✓	✓					1.2
DP: TS408 dispenser pneumatic 	151780	DP2K 050-MR-130	✓	✓	✓	✓	✓		1.3
	153098	DP2K 075-MR-130	✓	✓	✓	✓	✓		1.3

DELIVERING INNOVATION. INSPIRING CONFIDENCE.

EUROPE

medmix Switzerland AG

Ruetistrasse 7

9469 Haag, Switzerland

Phone +41 81 414 70 00

sales.industry@medmix.com

www.medmix.swiss

USA, SOUTH AMERICA, CANADA AND MEXICO

medmix USA Inc.

8 Willow St.

Salem, NH 03079, USA

Phone +1 603 893 2727

sales.industry@medmix.com

www.medmix.swiss

UK AND IRELAND

medmix UK Ltd.

1 Tealgate, Charnham Park, Hungerford
Berkshire, RG17 0YT, United Kingdom

Phone: +44 (0)1488 647 800

sales.industry@medmix.com

www.coxdispensers.com

ASIA PACIFIC

medmix China Ltd.

68 Bei Dou Lu, Minhang Shanghai
200245, China

Phone: +86 21 6430 68 68

sales.industry@medmix.com

www.medmix.swiss



Legal Notice: This brochure is a general presentation. The information contained in this publication is believed to be accurate and reliable but is not to be construed as implying any warranty or guarantee of performance. We waive any liability and indemnity for effects resulting from its application. Please, contact us for a description of the warranties and guarantees offered with our products. Directions for use and safety will be given separately. All information herein is subject to change without notice.

© 2022 medmix Switzerland AG All rights reserved.

medmix is a trademark belonging to medmix AG, and MIXPAC is a trademark belonging to medmix Switzerland AG.

MIXPAC™ B-System



2-COMPONENT INDUSTRY
SOLUTIONS

 medmix

INDUSTRY



OVERVIEW

MIXPAC™ B-SYSTEM





25/50/75 ML INDUSTRIAL SET

ACCESSORIES

ACCESSORIES

	ID	Article
	101651	BRT 205-10
	102274	IOT 406-15
	102277	IOT 506-15
	102356 102357	LA 05-00 LA 06-08

OUTLET TIP

-  Tapered Tip (S)
-  Straight Tip (D)
-  Luer Slip Tip (L)
-  Stepped Tip (T)

MIXER

-  ○ MBH (Helix)
-  ● MBQ (Quadro™)

25 mL

50 mL

CARTRIDGE

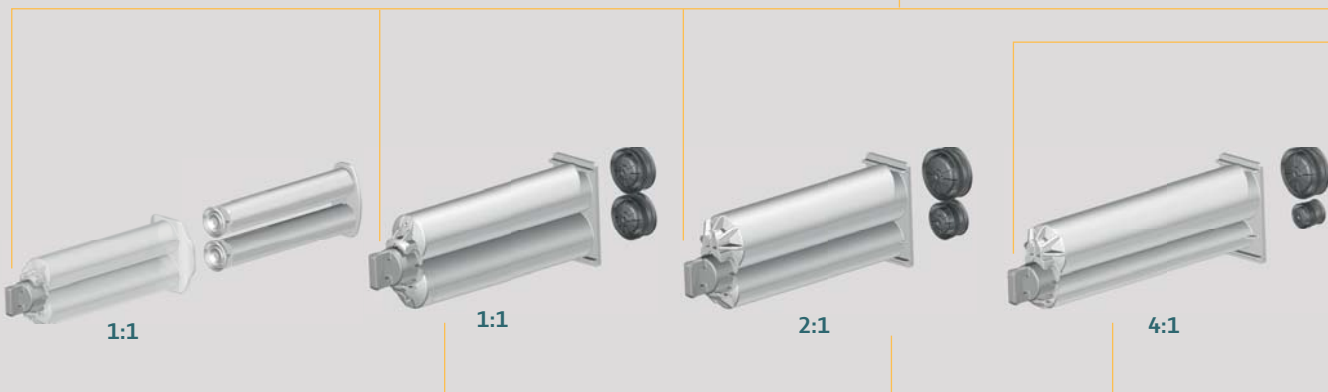

DISPENSER



INTERFACE CONVERTER

B-System => K-System



Ratio	ID	Article
1:1/2:1	128201	IBK 001-10
4:1/10:1	128202	IBKX 001-10

INTERFACE MIXER

K-System

Ratio	Article
1:1/2:1	MKH
4:1/10:1	MKHX

=> for further information see K-System

PISTON RETENTION PLATE

Ratio	ID	Article
1:1/2:1	113719	PRS 050-01-02
4:1/10:1	116564	PRS 050-04-10A



- MBHX (Helix)
- MBQX (Quadro™)

50 mL

75 mL



BS flange



MIXPAC™ B-SYSTEM

CARTRIDGE SET 25 INDUSTRIAL SET



1:1

CARTRIDGE ASSEMBLY 25 ML

Cap preassembled
Colors: ●



Plunger
Colors: (N) ●●●●

Cartridge
Colors: (N) ●

1:1

Ratio Set/ Volume	ID	Article	Cartridges Material/Color	Plunger	Units/ Box	Mixer Technology
1:1	116647	AB 025-01-10-01	PP/(N)	(N)	1000	MBH ○ MBQ ●
25 mL	116924	AB 025-01-10-02	PP/(N)	●	1000	MBH ○ MBQ ●
	116926	AB 025-01-10-05	PP/(N)	●	1000	MBH ○ MBQ ●
	116927	AB 025-01-10-07	PP/●	●	1000	MBH ○ MBQ ●
	116649	AB 025-01-30-01	PA/(N)	(N)	1000	MBH ○ MBQ ●
	116923	AB 025-01-30-07	PA/●	●	1000	MBH ○ MBQ ●
	129377	AB 025-01-30-09	PA/●	●	1000	MBH ○ MBQ ●

MIXPAC™ B-SYSTEM

CARTRIDGE SET

50/75 INDUSTRIAL SET



CARTRIDGE ASSEMBLY 50/75 ML

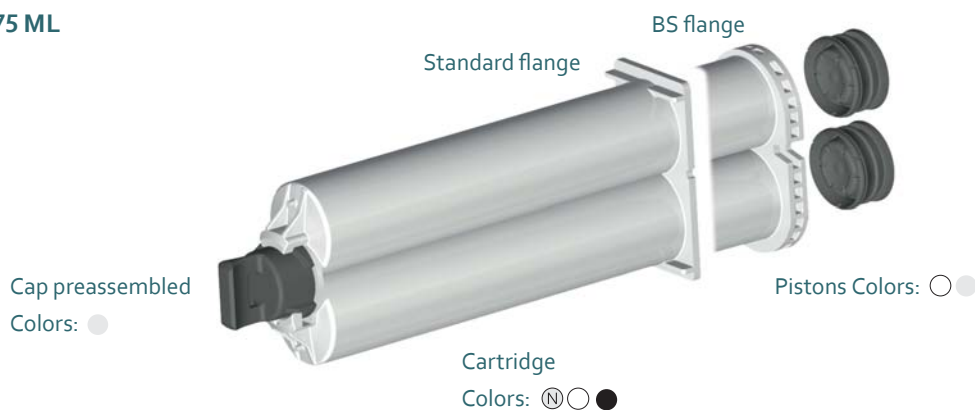





Ratio Set/ Volume	ID	Article	Cartridges Material/Color	Piston Material/Type	O-ring	Units/ Box	Mixer Technology	Matching Dispenser
1:1 50 mL	154853	AB 050-01-10-33	PP/○	HDPE, AirFT	–	1250	MBH ○ MBQ ●	DM ● DP ●
	154825	AB 050-01-10-34	PP/○	HDPE, AirFT	EPDM	1250	MBH ○ MBQ ●	DM ● DP ●
	166960	AB 050-01-10-35	PP/○	HDPE, AirFT	Silicone	1250	MBH ○ MBQ ●	DM ● DP ●
	154854	AB 050-01-10-37	PP/●	HDPE, AirFT	–	1250	MBH ○ MBQ ●	DM ● DP ●
	167299	AB 050-01-20-33	PBT/Ⓝ	HDPE, AirFT	–	1250	MBH ○ MBQ ●	DM ● DP ●
	167298	AB 050-01-20-34	PBT/Ⓝ	HDPE, AirFT	EPDM	1250	MBH ○ MBQ ●	DM ● DP ●
	154857	AB 050-01-30-33	PA/○	HDPE, AirFT	–	1250	MBH ○ MBQ ●	DM ● DP ●
	154485	AB 050-01-30-34	PA/○	HDPE, AirFT	EDPM	1250	MBH ○ MBQ ●	DM ● DP ●
	154851	AB 050-01-30-37	PA/●	HDPE, AirFT	–	1250	MBH ○ MBQ ●	DM ● DP ●
2:1 50 mL	154645	AB 050-02-10-33	PP/○	HDPE, AirFT	–	1250	MBH ○ MBQ ●	DM ● DP ●
	154646	AB 050-02-10-34	PP/○	HDPE, AirFT	EPDM	1250	MBH ○ MBQ ●	DM ● DP ●
	154676	AB 050-02-30-33	PP/○	HDPE, AirFT	–	1250	MBH ○ MBQ ●	DM ● DP ●
	154705	AB 050-02-30-34	PA/○	HDPE, AirFT	EPDM	1250	MBH ○ MBQ ●	DM ● DP ●
	154707	AB 050-02-30-35	PA/Ⓝ	HDPE, AirFT	–	1250	MBH ○ MBQ ●	DM ● DP ●
4:1 50 mL	116421	AB 050-04-10-01	PP/○	A-piston, PP, self-venting lip seal; B-piston, PP, solid lip seal	–	625	MBHX ● MBQX ●	DM ● DP ●
	128606	AB 050-04-10-02	PP/○	A-piston, PP, self-venting lip seal; B-piston, PP, solid lip seal with O-ring	EPDM	625	MBHX ● MBQX ●	DM ● DP ●
	167304	AB 050-04-20-01	PBT/Ⓝ	A-piston, PA, self-venting lip seal; B-piston, PA, solid lip seal	–	625	MBHX ● MBQX ●	DM ● DP ●
10:1 50 mL	116423	AB 050-10-10-01	PP/○	A-piston, PP, self-venting lip seal; B-piston, PP, solid lip seal	–	625	MBHX ● MBQX ●	DM ● DP ●
	151982	AB 050-10-10-02	PP/○	A-piston, PA, self-venting lip seal; B-piston, HDPE, solid piston with O-ring	EDPM	625	MBHX ● MBQX ●	DM ● DP ●
	167300	AB 050-10-20-01	PBT/Ⓝ	A-piston, PA, self-venting lip seal; B-piston, PA, solid lip seal	–	625	MBHX ● MBQX ●	DM ● DP ●

BS FLANGE

Ratio Set/ Volume	ID	Article	Cartridges Material/Color	Piston Material/ Type	O-ring	Units/ Box	Mixer Technology	Matching Dispenser
1:1 50 mL	154850	AB S50-01-10-33	PP/○	HDPE, AirFT	–	1250	MBH ● MBQ ○	DS ● DP ●
	154829	AB S50-01-10-37	PP/●	HDPE, AirFT	–	1250	MBHX ● MBQX ●	DS ● DP ●
	154828	AB S50-01-30-33	PA/○	HDPE, AirFT	–	1250	MBH ● MBQ ○	DS ● DP ●
75 mL	158029	AB S75-01-10-33	PP/⊗	HDPE, AirFT	–	625	MBHX ● MBQX ●	DS ● DP ●
2:1 50 mL	154708	AB S50-02-10-33	PP/○	HDPE, AirFT	–	1250	MBHX ● MBQX ●	DS ● DP ●
10:1 50 mL	152458	AB S50-10-10-01	PP/○	PP, self venting lip seal	–	625	MBHX ● MBQX ●	DS ● DP ●
	167251	AB S50-10-20-01	PBT/⊗	PP, self venting lip seal	–	1250	MBHX ● MBQX ●	DS ● DP ●
	167253	AB S50-10-20-06	PBT/⊗	PA, solid lip seal with O-ring	Silicone	1250	MBHX ● MBQX ●	DS ● DP ●
	167288	AB S50-10-20-08	PBT/⊗	A-piston, PA, self-venting lip seal / B-piston, PA, solid lip seal with O-ring	Silicone	1250	MBHX ● MBQX ●	DS ● DP ●
10:1 75 mL	167271	AB S75-10-20-02	PBT/⊗	PA, solid lip seal with O-ring	Silicone	900	MBHX ● MBQX ●	DS ● DP ●
	167273	AB S75-10-20-03	PBT/⊗	PA, solid lip seal with O-ring	Silicone	350	MBHX ● MBQX ●	DS ● DP ●
	167274	AB S75-10-20-05	PBT/⊗	A-piston, PA, self-venting lip seal / B-piston, PA, self-venting lip seal with O-ring	Silicone	900	MBHX ● MBQX ●	DS ● DP ●

MATCHING MIXERS

	ID	Article	Number of Elements	Inner Diameter Ø mm/inch	Waste Volume (mL)	Units/ Box	Outlet Tip				Accessories							
							Stepped Tip (T)	Straight Tip (D)	Luer Slip Tip (L)	Tapered Tip (S)	LA 05-00	LA 06-08	BRT 205-10	IOT 406-15	IOT 506-15	IOT 212-20	IOR 209-20	IOT 715-50
 1:1/2:1 MBH	116457	MBH 03-12D	12	3.2/0.126	0.49	8000	✓											
	116458	MBH 03-12S	12	3.2/0.126	0.49	8000			✓									
	116459	MBH 03-16D	16	3.2/0.126	0.63	8000	✓											
	116460	MBH 03-16L	16	3.2/0.126	0.63	7000			✓									
	116461	MBH 03-16S	16	3.2/0.126	0.59	8000				✓								
	116462	MBH 04-12D	12	4.2/0.165	0.84	7000	✓											
	116463	MBH 04-16D	16	4.2/0.165	1.04	5000	✓											
	116464	MBH 04-16S	16	4.2/0.165	1.04	5000				✓								
	116575	MBH 05-06T	6	5.4/0.213	0.94	8000	✓				✓							
	116465	MBH 05-12D	12	5.4/0.213	1.52	5000	✓					✓			✓			
	116466	MBH 05-14D	14	5.4/0.213	1.91	4000	✓						✓		✓			
	116467	MBH 05-16T	16	5.4/0.213	1.91	4000	✓				✓							
	116468	MBH 05-20T	20	5.4/0.213	2.29	3000	✓				✓							
	116469	MBH 06-11D	11	6.5/0.256	2.28	4000	✓					✓			✓			
	116470	MBH 06-16T	16	6.5/0.256	3.14	3000	✓					✓						
	116471	MBH 06-20T	20	6.5/0.256	3.76	2000	✓					✓						✓
116472	MBH 07-11D	11	7.5/0.295	3.05	4000	✓												
 4:1/10:1 MBHX	116473	MBHX 03-16S	16	3.2/0.126	0.60	7000			✓									
	116474	MBHX 04-16D	16	4.2/0.165	1.05	6000	✓											
	116576	MBHX 04-16S	16	4.2/0.165	1.05	5000				✓								
	116475	MBHX 05-12D	12	5.4/0.213	1.52	5000	✓					✓	✓	✓				
	116476	MBHX 05-16T	16	5.4/0.213	1.91	4000	✓				✓							
	116477	MBHX 05-20T	20	5.4/0.213	2.07	3000	✓				✓							
	116478	MBHX 06-16D	16	6.5/0.256	3.14	3000	✓					✓						
	116480	MBHX 06-16T	16	6.5/0.256	3.04	3000	✓					✓		✓				
	116481	MBHX 06-20T	20	6.5/0.256	3.79	2000	✓					✓						
	 1:1/2:1 MBQ	114144	MBQ 05-16L	16	5.3/0.209	1.88	3000			✓								
154801		MBQ 05-16L-12 ●*	16	5.3/0.209	1.88	3000			✓									
114145		MBQ 05-24L	24	5.3/0.209	2.60	3000			✓									
 4:1/10:1 MBQX	116063	MBQX 05-16L	16	5.3/0.209	1.72	3000			✓									
	116062	MBQX 05-24L	24	5.3/0.209	2.37	3000			✓									

* different color

MATCHING DISPENSERS

		ID	Article	Flange			Ratio				Force (kN)
				B 50	B 550	B 75	1:1	2:1	4:1	10:1	
DM: DMA/DMB dispenser manual		101875	DMA 51-00-10	✓			✓	✓		1.2	
		116795	DMB 50-04-01	✓					✓	1.2	
		116794	DMB 50-10-01	✓						✓	1.2
DS dispenser manual		101934	DS 53-01-00		✓		✓	✓		1.2	
		109146	DS 51-04-00		✓				✓	1.2	
		101929	DS 51-10-00		✓					✓	1.2
		115676	DS 75-10-00		✓					✓	1.2
		110938	DS 77-01-00		✓		✓				1.2
DP: TS408 dispenser pneumatic		151780	DP2K 050-MR-130	✓			✓	✓		1.3	
		153094	DP2K 050-41-130	✓					✓	✓	1.3
		151886	DP2K S50-10-130		✓					✓	1.3
		153098	DP2K 075-MR-130			✓	✓	✓	✓	✓	1.3

DELIVERING INNOVATION. INSPIRING CONFIDENCE.

EUROPE

medmix Switzerland AG

Ruetistrasse 7

9469 Haag, Switzerland

Phone +41 81 414 70 00

sales.industry@medmix.com

www.medmix.swiss

USA, SOUTH AMERICA, CANADA AND MEXICO

medmix USA Inc.

8 Willow St.

Salem, NH 03079, USA

Phone +1 603 893 2727

sales.industry@medmix.com

www.medmix.swiss

UK AND IRELAND

medmix UK Ltd.

1 Tealgate, Charnham Park, Hungerford

Berkshire, RG17 0YT, United Kingdom

Phone: +44 (0)1488 647 800

sales.industry@medmix.com

www.coxdispensers.com

ASIA PACIFIC

medmix China Ltd.

68 Bei Dou Lu, Minhang Shanghai

200245, China

Phone: +86 21 6430 68 68

sales.industry@medmix.com

www.medmix.swiss



Legal Notice: This brochure is a general presentation. The information contained in this publication is believed to be accurate and reliable but is not to be construed as implying any warranty or guarantee of performance. We waive any liability and indemnity for effects resulting from its application. Please, contact us for a description of the warranties and guarantees offered with our products. Directions for use and safety will be given separately. All information herein is subject to change without notice.

© 2022 medmix Switzerland AG All rights reserved.

medmix is a trademark belonging to medmix AG, and MIXPAC is a trademark belonging to medmix Switzerland AG.

MIXPAC™ C-System



2-COMPONENT INDUSTRY
SOLUTIONS

 medmix

INDUSTRY



OVERVIEW

MIXPAC™ C-SYSTEM

200/400 ML INDUSTRIAL SET

ACCESSORIES

ACCESSORIES

	ID	Article
	103663	TA 10-ET
	103664	TC 10-ET
	101656 101657	BSD 10-25 BSD 10-40
	300326	BSDQ 08-38
	102357 102358	LA 06-08 LA 10-00

OUTLET TIP

-  Tapered Tip (S)
-  Straight Tip (D)
-  Luer Slip Tip (L)
-  Stepped Tip (T)

MIXER

-  ○ MGH (Helix)
-  ○ MCH (Helix)
-  ● MCQ (Quadro™)
-  ● MGQ (Quadro™)

200 mL

CARTRIDGE

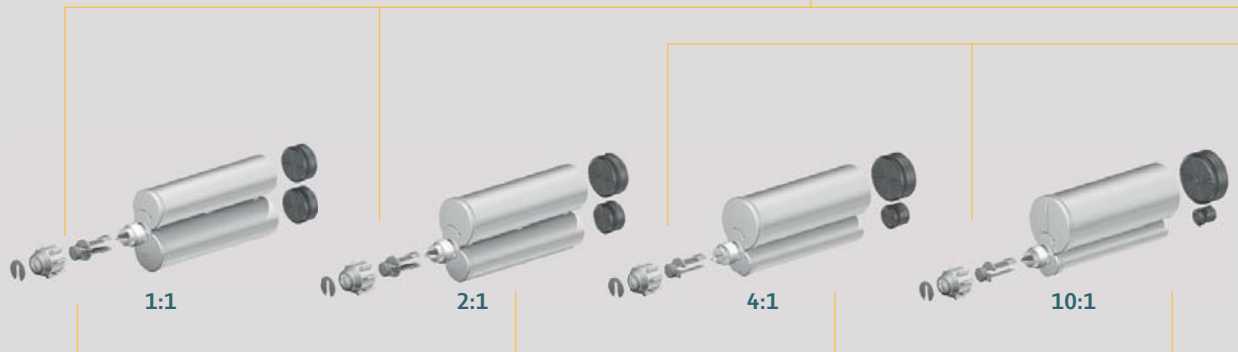

DISPENSER





400 mL



CARTRIDGE SET

200/400 INDUSTRIAL SET





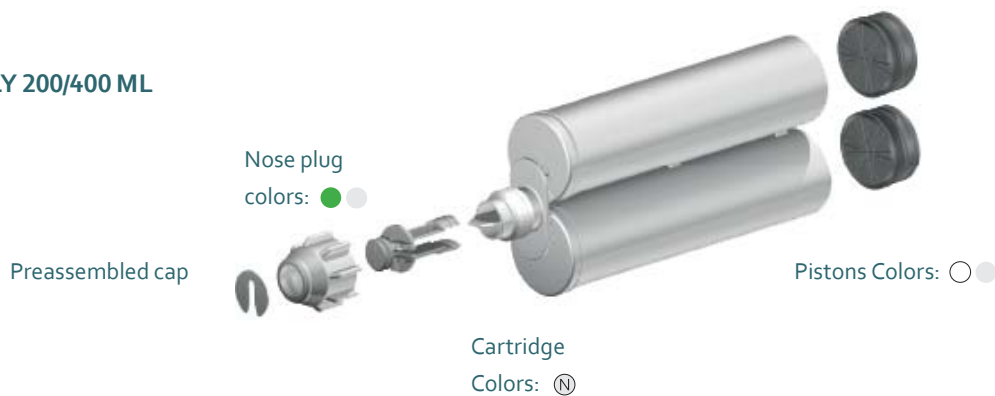

CARTRIDGE ASSEMBLY 200/400 ML





Ratio Set/ Volume	ID	Article	Cartridges Material/Color	Piston Material/ Type	O-ring	Units/ Box	Mixer Technology	Matching Dispenser
1:1 200 mL	112158	AC 200-01-10-01	PP/Ⓝ	PP, self-venting	–	300	MCH ○ MCQ ● MGH ○ MGQ ●	DM ● DP ●
	128249	AC 200-01-10-02	PP/Ⓝ	PA, self-venting	EPDM	300	MCH ○ MCQ ● MGH ○ MGQ ●	DM ● DP ●
	116410	AC 200-01-10-04	PP/Ⓝ	PP, self-venting	–	300	MCH ○ MCQ ● MGH ○ MGQ ●	DM ● DP ●
	116578	AC 200-01-10-05	PP/Ⓝ	PP, self-venting	EPDM	300	MCH ○ MCQ ● MGH ○ MGQ ●	DM ● DP ●
1:1 400 mL	103721	AC 400-01-10-01	PP/Ⓝ	PP, self-venting	–	180	MCH ○ MCQ ● MGH ○ MGQ ●	DM ● DP ● DB ●
	113209	AC 400-01-10-02	PP/Ⓝ	PP, self-venting	EPDM	180	MCH ○ MCQ ● MGH ○ MGQ ●	DM ● DP ● DB ●
	116317	AC 400-01-10-04	PP/Ⓝ	PP, self-venting	–	180	MCH ○ MCQ ● MGH ○ MGQ ●	DM ● DP ● DB ●
	154402	AC 400-01-30-01	PA/Ⓝ	PA, self-venting	–	180	MCH ○ MCQ ● MGH ○ MGQ ●	DM ● DP ● DB ●
	154750	AC 400-01-30-04	PA/Ⓝ	PA, self-venting	–	180	MCH ○ MCQ ● MGH ○ MGQ ●	DM ● DP ● DB ●
2:1 200 mL	112699	AC 200-02-10-01	PP/Ⓝ	PP, self-venting	–	280	MCH ○ MCQ ● MGH ○ MGQ ●	DM ● DP ●
	129165	AC 200-02-10-05	PP/Ⓝ	PP, self-venting	EPDM	280	MCH ○ MCQ ● MGH ○ MGQ ●	DM ● DP ●
2:1 400 mL	108663	AC 400-02-10-01	PP/Ⓝ	PP, self-venting	–	175	MCH ○ MCQ ● MGH ○ MGQ ●	DM ● DP ● DB ●
	116318	AC 400-02-10-04	PP/Ⓝ	PP, self-venting	–	175	MCH ○ MCQ ● MGH ○ MGQ ●	DM ● DP ● DB ●
	129156	AC 400-02-10-05	PP/Ⓝ	PP, self-venting	EPDM	175	MCH ○ MCQ ● MGH ○ MGQ ●	DM ● DP ● DB ●
4:1 200 mL	127894	AC 200-04-10-04	PP/Ⓝ	PP, self-venting	–	265	MCH ○ MCQ ● MGH ○ MGQ ●	DM ● DP ●
4:1 400 mL	112530	AC 400-04-10-01	PP/Ⓝ	PP, self-venting	–	170	MCHX ● MGH ○ MGQ ●	DM ● DP ● DB ●
	115454	AC 400-04-10-05	PP/Ⓝ	PP, self-venting	–	170	MCHX ● MGH ○ MGQ ●	DM ● DP ● DB ●
	116413	AC 400-04-10-04	PP/Ⓝ	PP, self-venting	–	170	MCHX ● MGH ○ MGQ ●	DM ● DP ● DB ●
	128441	AC 400-04-10-06	PP/Ⓝ	PP, self-venting	EPDM	170	MCHX ● MGH ○ MGQ ●	DM ● DP ● DB ●
10:1 200 mL	108397	AC 200-10-10-02	PP/Ⓝ	PP, self-venting	–	250	MCHX ● MGH ○ MGQ ●	DM ● DP ●
	116532	AC 200-10-10-03	PP/Ⓝ	PP, self-venting	EPDM	250	MCHX ● MGH ○ MGQ ●	DM ● DP ●
	127919	AC 200-10-10-04	PP/Ⓝ	A-piston PP, self-venting B-piston PP, self-venting	EPDM	250	MCHX ● MGH ○ MGQ ●	DM ● DP ●
10:1 400 mL	112622	AC 400-10-10-01	PP/Ⓝ	PP, self-venting	–	165	MCHX ● MGH ○ MGQ ●	DM ● DP ● DB ●
	116580	AC 400-10-10-04	PP/Ⓝ	PP, self-venting	–	165	MCHX ● MGH ○ MGQ ●	DM ● DP ● DB ●
	113820	AC 400-10-10-06	PP/Ⓝ	PP, self-venting	–	165	MCHX ● MGH ○ MGQ ●	DM ● DP ● DB ●
	113615	AC 400-10-10-05	PP/Ⓝ	PP, self-venting Cap partially pre-assembled	–	165	MCHX ● MGH ○ MGQ ●	DM ● DP ● DB ●

MATCHING MIXERS

	ID	Article	Number of Elements	Inner Diameter Ø mm/inch	Waste Volume (mL)	Units/Box	Outlet Tip				Accessories								
							Stepped Tip (T)	Straight Tip (D)	Luer Slip Tip (L)	Tapered Tip (S)	BSD 10-25	BSD 10-40	LA 05-00	LA 06-08	LA 10-00	BSDQ 08-38	TA 10-ET	TC 10-ET	
1:1/2:1 MCH 	102414	MCH 05-18T	18	5.0/0.197	2.10	3000	✓					✓							
	102415	MCH 05-24T	24	5.0/0.197	2.00	2000	✓					✓							
	102416	MCH 05-32T	32	5.0/0.197	2.60	2000	✓					✓							
	102417	MCH 06-18T	18	6.0/0.236	3.60	2000	✓							✓					
	102418	MCH 06-24T	24	6.0/0.236	4.20	2000	✓							✓					
	102419	MCH 06-32T	32	6.0/0.236	5.00	1700	✓							✓					
	102421	MCH 08-18T	18	8.0/0.315	6.70	2000	✓							✓					
	102424	MCH 08-24T	24	8.0/0.315	8.50	1500	✓							✓					
	102425	MCH 08-32T	32	8.0/0.315	10.90	1200	✓							✓					
	102427	MCH 1008-18S	18	8.0/0.315	10.20	1000				✓									
	102429	MCH 10-18T	18	10.0/0.394	12.30	1400	✓								✓				
	102430	MCH 10-20D	20	10.0/0.394	12.60	1200		✓			✓	✓					✓	✓	
	102432	MCH 10-24D	24	10.0/0.394	15.30	1000		✓			✓	✓					✓	✓	
	102431	MCH 10-24T	24	10.0/0.394	14.60	1000	✓								✓				
	102433	MCH 10-32T	32	10.0/0.394	17.70	900	✓								✓				
	102434	MCH 13-12T	13	10.0/0.394	14.70	1400	✓												
	102435	MCH 13-18T	18	13.0/0.512	21.00	1000	✓												
	102437	MCH 13-24T	24	13.0/0.512	27.30	800	✓												
	102438	MCH 13-32T	32	13.0/0.512	25.70	600	✓												
4:1/10:1 MCHX 	102440	MCHX 08-18T	18	8.0/0.315	6.40	1800	✓							✓					
	102443	MCHX 08-24T	24	8.0/0.315	9.30	1500	✓							✓					
	102444	MCHX 10-12T	12	10.0/0.394	9.60	2000	✓							✓					
	102445	MCHX 10-18T	18	10.0/0.394	11.90	1400	✓							✓					
	102446	MCHX 10-24T	24	10.0/0.394	16.20	1000	✓							✓					
	102447	MCHX 13-12T	12	13.0/0.512	11.60	1200	✓												
	112498	MCHX 15-12-30	12	15.0/591	27.00	1000	✓												
1:1/2:1 MCQ 	300002	MCQ 05-24L	24	5.3/207	3.46	1500			✓										
	300006	MCQ 07-24T	24	7.5/295	6.19	1000	✓												
	300455	MCQ 08-24T	24	8.7/0.343	8.44	1300	✓								✓				
	300375	MCQ 08-32T	32	8.7/0.343	10.37	900	✓									✓			
	300496	MCQ 10-24T-01	24	10.7/0.421	14.04	800	✓												
	300377	MCQ 10-32T	32	10.7/0.421	18.45	600	✓												
1:1/2:1/4:1/10:1 MGH 	102480	MGH 08-06S	6	8.0/0.315	3.67	1500					✓								
1:1/2:1/4:1/10:1 MGQ 	300469	MGQ 08-18T	18	8.7/0.343	6.70	1200	✓									✓			
	300454	MGQ 08-20D	20	8.7/0.343	7.57	1000		✓											
	300453	MGQ 08-20T	20	8.7/0.343	7.34	1000	✓									✓			
	300462	MGQ 08-24D	24	8.7/0.343	8.61	800		✓											
	300461	MGQ 08-24T	24	8.7/0.343	8.76	800	✓									✓			
	300493	MGQ 10-19D	19	10.7/0.421	12.15	800		✓											
	300497	MGQ 10-24D	24	10.7/0.421	14.49	650		✓											

MATCHING DISPENSERS

	ID	Article	Ratio				Force (kN)
			1:1	2:1	4:1	10:1	
DM2X dispenser manual 	165807	DM2X 400-01-60	✓	✓			6.0
	165808	DM2X 400-04-60			✓		6.0
	165809	DM2X 400-10-60				✓	6.0
DP2X dispenser pneumatic 	165864	DP2X 400-01-50	✓	✓			5.0
	165865	DP2X 400-04-50	✓	✓			5.0
	165866	DP2X 400-10-50			✓		5.0
DB2K dispenser battery 	152603	DB2K 400-01-500	✓				5.0
	152605	DB2K 400-02-500		✓			5.0
	152607	DB2K 400-04-500			✓		5.0
	152609	DB2K 400-10-500				✓	5.0

DELIVERING INNOVATION. INSPIRING CONFIDENCE.

EUROPE

medmix Switzerland AG

Ruetistrasse 7
9469 Haag, Switzerland
Phone +41 81 414 70 00
sales.industry@medmix.com
www.medmix.swiss

**USA, SOUTH AMERICA,
CANADA AND MEXICO**

medmix USA Inc.

8 Willow St.
Salem, NH 03079, USA
Phone +1 603 893 2727
sales.industry@medmix.com
www.medmix.swiss

UK AND IRELAND

medmix UK Ltd.

1 Tealgate, Charnham Park, Hungerford
Berkshire, RG17 0YT, United Kingdom
Phone: +44 (0)1488 647 800
sales.industry@medmix.com
www.coxdispensers.com

ASIA PACIFIC

medmix China Ltd.

68 Bei Dou Lu, Minhang Shanghai
200245, China
Phone: +86 21 6430 68 68
sales.industry@medmix.com
www.medmix.swiss



Legal Notice: This brochure is a general presentation. The information contained in this publication is believed to be accurate and reliable but is not to be construed as implying any warranty or guarantee of performance. We waive any liability and indemnity for effects resulting from its application. Please, contact us for a description of the warranties and guarantees offered with our products. Directions for use and safety will be given separately. All information herein is subject to change without notice.

© 2022 medmix Switzerland AG All rights reserved.

medmix is a trademark belonging to medmix AG, and MIXPAC is a trademark belonging to medmix Switzerland AG.

MIXPAC™ F-System



2-COMPONENT INDUSTRY
SOLUTIONS

 medmix

INDUSTRY 

OVERVIEW

MIXPAC™ F-SYSTEM

200/400 ML INDUSTRIAL SET

ACCESSORIES



ACCESSORIES

	ID	Article
	103663	TA 10-ET
	103664	TC 10-ET
	101656 101657 116166 116165	BSD 10-25 BSD 10-40 BSD 13-50 BSD 08-50
	300326	BSDQ 08-38
	102357 102358	LA 06-08 LA 10-00

OUTLET TIP

-  Straight Tip (D)
-  Luer Slip Tip (L)
-  Stepped Tip (T)

MIXER

-  ○ MFH (Helix)
-  ● MFQ (Quadro™)

200 mL

CARTRIDGE

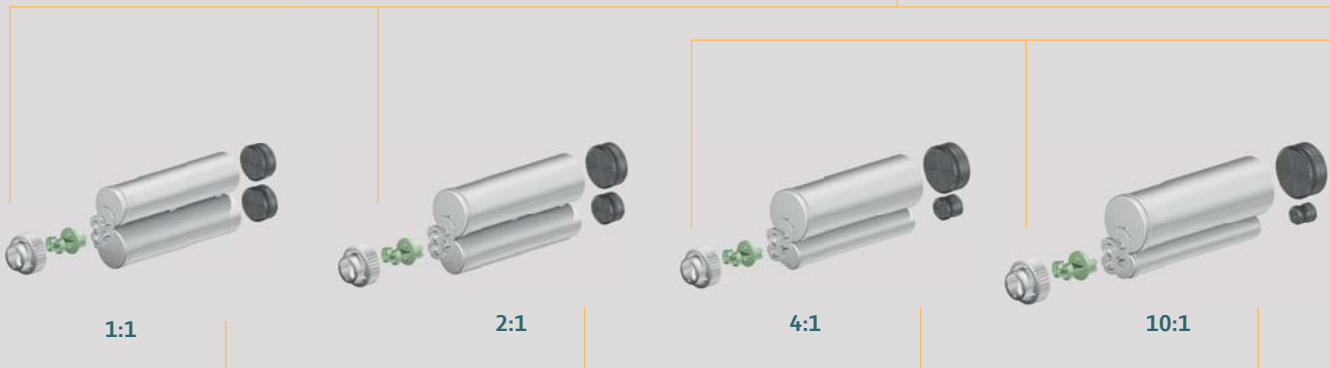

DISPENSER



INTERFACE CONVERTER

F-System => B-System



Ratio	ID	Article
1:1/2:1	128201	IBK 001-10
4:1/10:1	128202	IBKX 001-10

INTERFACE MIXER

B-System

Ratio	Article
1:1/2:1	MKH
4:1/10:1	MKHX

=> for further information see K-System



400 mL

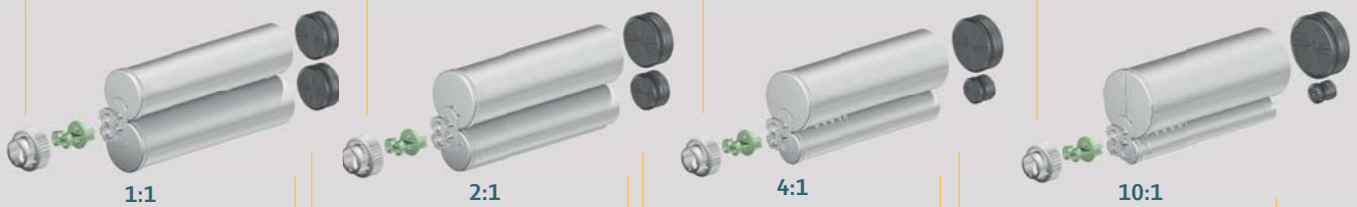

MIXPAC™ F-SYSTEM

CARTRIDGE SET

200 INDUSTRIAL SET





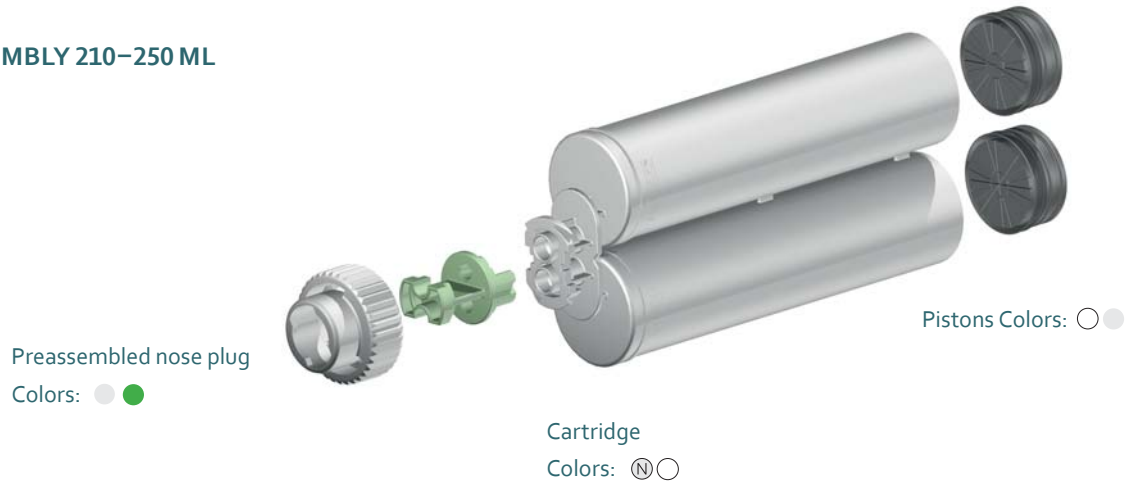

CARTRIDGE ASSEMBLY 210–250 ML





Ratio Set/ Volume	ID	Article	Cartridges Material/Color	Piston Material/Type	O-ring	Units/ Box	Mixer Technology	Matching Dispenser
1:1 200 mL	112390	AF 200-01-10-01	PP/Ⓝ	PP, self-venting	–	300	MFH ○ MFQ ●	DM ● DP ●
	128960	AF 200-01-10-05	PP/Ⓝ	PP, self-venting	–	300	MFH ○ MFQ ●	DM ● DP ●
	154401	AF 200-01-30-01	PA/Ⓝ	PA, self-venting	–	300	MFH ○ MFQ ●	DM ● DP ●
2:1 200 mL	112398	AF 200-02-10-01	PP/Ⓝ	PP, self-venting	–	280	MFH ○ MFQ ●	DM ● DP ●
	128607	AF 200-02-10-02	PP/Ⓝ	PP, self-venting	EPDM	280	MFH ○ MFQ ●	DM ● DP ●
	151831	AF 200-02-10-05	PP/Ⓝ	PP, self-venting	–	280	MFH ○ MFQ ●	DM ● DP ●
	159748	AF 200-02-30-05	PA/Ⓝ	PA, self-venting	–	280	MFH ○ MFQ ●	DM ● DP ●
4:1 200 mL	112393	AF 200-04-10-01	PP/Ⓝ	PP, self-venting	–	265	MFHX ● MFQX ●	DM ● DP ●
10:1 200 mL	112402	AF 200-10-10-01	PP/Ⓝ	PP, self-venting	–	250	MFHX ● MFQX ●	DM ● DP ●
	128961	AF 200-10-10-05	PP/Ⓝ	PP, self-venting	–	250	MFHX ● MFQX ●	DM ● DP ●
	167264	AF 200-10-20-01	PBT/Ⓝ	PA, self-venting	–	250	MFHX ● MFQX ●	DM ● DP ●
	167263	AF 200-10-20-05	PBT/Ⓝ	PA, self-venting	–	250	MFHX ● MFQX ●	DM ● DP ●

MATCHING MIXERS

	ID	Article	Number of Elements	Inner Diameter Ø mm/inch	Waste Volume (mL)	Units/Box	Outlet Tip			Accessories									
							Stepped Tip (T)	Straight Tip (D)	Luer Slip Tip (L)	TA10-ET	TC10-ET	LA06-08	LA10-00	BSD-08-50	BSD-10-25	BSD-10-40	BSD-13-50	BSDQ-08-38	
1:1/2:1 MFH 	102466	MFH 06-18T	18	6.0/0.236	4.36	1700	✓			✓									
	102467	MFH 06-24T	24	6.0/0.236	5.40	1400	✓			✓									
	116040	MFH 06-32T	32	6.0/0.236	6.65	1200	✓			✓									
	102468	MFH 08-18T	18	8.0/0.315	7.40	1400	✓			✓	✓								
	102469	MFH 08-24T	24	8.0/0.315	9.30	1200	✓			✓	✓								
	102470	MFH 08-32T	32	8.0/0.315	11.85	900	✓			✓	✓								
	102471	MFH 10-18T	18	10.0/0.394	13.09	1000	✓		✓	✓		✓	✓	✓	✓				
	102472	MFH 10-24T	24	10.0/0.394	16.89	900	✓		✓	✓		✓	✓	✓	✓				
	110583	MFH 10-32T	32	10.0/0.394	21.94	500	✓		✓	✓		✓	✓	✓	✓				
	151603	MFH 13-18T	18	13.0/0.512	20.56	800	✓											✓	
	151604	MFH 13-24T	24	13.0/0.512	26.31	600	✓											✓	
	4:1/10:1 MFHX 	102473	MFHX 06-18T	18	6.0/0.236	4.16	1700	✓				✓							
		102474	MFHX 06-24T	24	6.0/0.236	5.20	1400	✓				✓							
113275		MFHX 06-32T	32	6.0/0.236	6.56	1200	✓				✓								
102475		MFHX 08-18T	18	8.0/0.315	7.28	1400	✓				✓	✓							
102476		MFHX 08-24T	24	8.0/0.315	9.14	1200	✓				✓	✓							
112720		MFHX 08-32T	32	8.0/0.315	11.55	900	✓				✓	✓							
102477		MFHX 10-18T	18	10.0/0.394	12.96	1000	✓		✓	✓		✓	✓	✓	✓				
102478		MFHX 10-24T	24	10.0/0.394	16.70	900	✓		✓	✓		✓	✓	✓	✓				
113250		MFHX 10-32T	32	10.0/0.394	21.22	500	✓		✓	✓		✓	✓	✓	✓				
151605		MFHX 13-18T	18	13.0/0.512	20.73	800	✓											✓	
151606		MFHX 13-24T	24	13.0/0.512	26.48	600	✓											✓	
1:1/2:1 MFQ 	116032	MFQ 05-16L	16	5.3/0.209	2.90	2500		✓											
	116033	MFQ 05-24L	24	5.3/0.209	3.52	2000		✓											
	116034	MFQ 07-24T	24	7.5/0.295	6.11	1500	✓												
	115959	MFQ 08-24T	24	8.7/0.343	8.69	750	✓											✓	
	116734	MFQ 08-32D	32	8.7/0.343	11.10	800		✓											
	116035	MFQ 10-24T	24	10.7/0.421	14.75	600	✓												
4:1/10:1 MFQX 	116036	MFQX 05-16L	16	5.3/0.209	3.07	2500		✓											
	116037	MFQX 05-24L	24	5.3/0.209	3.69	2000		✓											
	116038	MFQX 07-24T	24	7.5/0.295	6.28	1500	✓												
	116039	MFQX 08-24T	24	8.7/0.343	8.86	750	✓											✓	
	116735	MFQX 08-32D	32	8.7/0.343	11.10	800		✓											
	116044	MFQX 10-24T	24	10.7/0.421	14.92	600	✓												

MATCHING DISPENSERS

	ID	Article	Ratio				Force (kN)
			1:1	2:1	4:1	10:1	
DM2X dispenser manual 	165803	DM2X 200-01-52	✓	✓			5.2
	165804	DM2X 200-04-52			✓		5.2
	165805	DM2X 200-10-52				✓	5.2
DP2X dispenser pneumatic 	165860	DP2X 200-01-25	✓	✓			2.5
	165861	DP2X 200-04-25			✓		2.5
	165862	DP2X 200-10-25				✓	2.5

CARTRIDGE SET

400 INDUSTRIAL SET





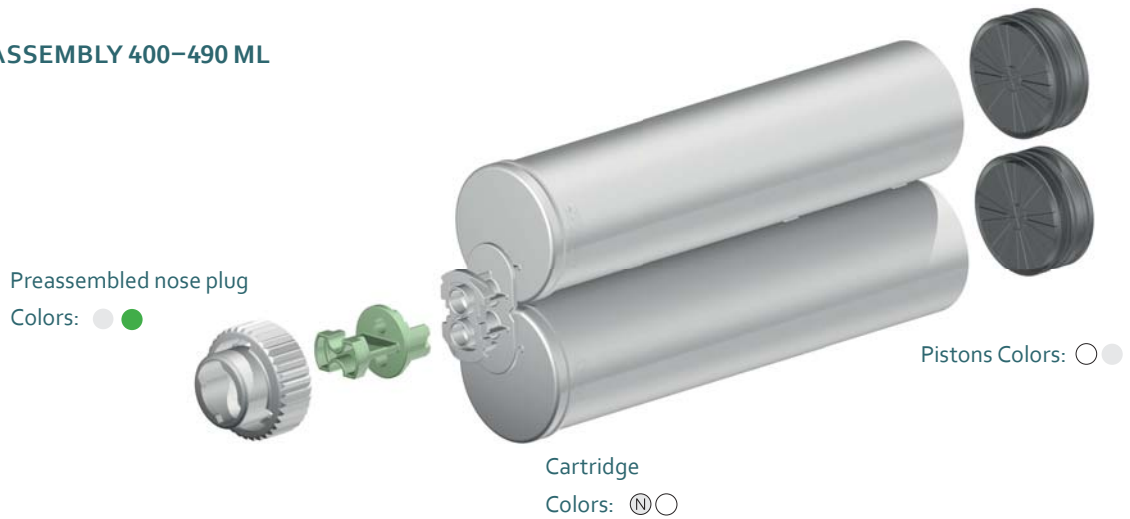

CARTRIDGE ASSEMBLY 400–490 ML





Ratio Set/ Volume	ID	Article	Cartridges Material/Color	Piston Material/Type	O-ring	Units/ Box	Mixer Technology	Matching Dispenser
1:1 400 mL	112410	AF 400-01-10-01	PP/(N)	PP, self-venting	–	180	MFH ○ MFQ ●	DM ● DP ● DB ●
	117111	AF 400-01-10-02	PP/(N)	PP, self-venting	EPDM	180	MFH ○ MFQ ●	DM ● DP ● DB ●
	128010	AF 400-01-10-05	PP/(N)	PP, self-venting	–	180	MFH ○ MFQ ●	DM ● DP ● DB ●
	167267	AF 400-01-20-04	PBT/(N)	PA, self-venting	–	180	MFH ○ MFQ ●	DM ● DP ● DB ●
	167266	AF 400-01-20-05	PBT/(N)	PA, self-venting	–	180	MFH ○ MFQ ●	DM ● DP ● DB ●
2:1 400 mL	112407	AF 400-02-10-01	PP/(N)	PP, self-venting	–	175	MFH ○ MFQ ●	DM ● DP ● DB ●
	113679	AF 400-02-10-02	PP/(N)	PP, self-venting	EPDM	175	MFH ○ MFQ ●	DM ● DP ● DB ●
	128959	AF 400-02-10-05	PP/(N)	PP, self-venting	–	175	MFH ○ MFQ ●	DM ● DP ● DB ●
	154807	AF 400-02-30-01	PA/(N)	PA, self-venting	EPDM	175	MFH ○ MFQ ●	DM ● DP ● DB ●
4:1 400 mL	112397	AF 400-04-10-01	PP/(N)	PP, self-venting	–	170	MFHX ● MFQX ●	DM ● DP ● DB ●
	167282	AF 400-04-20-01	PBT/(N)	PA, self-venting	–	170	MFHX ● MFQX ●	DM ● DP ● DB ●
10:1 400 mL	113745	AF 400-10-10-01	PP/(N)	PP, self-venting	–	165	MFHX ● MFQX ●	DM ● DP ● DB ●
	116612	AF 400-10-10-05	PP/(N)	PP, self-venting	–	165	MFHX ● MFQX ●	DM ● DP ● DB ●
	167187	AF 400-10-20-01	PBT/(N)	PA, self-venting	–	165	MFHX ● MFQX ●	DM ● DP ● DB ●
	167188	AF 400-10-20-03	PBT/(N)	PA, self-venting	–	165	MFHX ● MFQX ●	DM ● DP ● DB ●
	167186	AF 400-10-20-05	PBT/(N)	PA, self-venting	–	165	MFHX ● MFQX ●	DM ● DP ● DB ●

MATCHING MIXERS

	ID	Article	Number of Elements	Inner Diameter Ø mm/inch	Waste Volume (mL)	Units/Box	Outlet Tip			Accessories									
							Stepped Tip (T)	Straight Tip (D)	Luer Slip Tip (L)	TA10-ET	TC10-ET	LA06-08	LA10-00	BSD-08-50	BSD-10-25	BSD-10-40	BSD-13-50	BSDQ-08-38	
1:1/2:1 MFH 	102466	MFH 06-18T	18	6.0/0.236	4.36	1700	✓			✓									
	102467	MFH 06-24T	24	6.0/0.236	5.40	1400	✓			✓									
	116040	MFH 06-32T	32	6.0/0.236	6.65	1200	✓			✓									
	102468	MFH 08-18T	18	8.0/0.315	7.40	1400	✓				✓	✓							
	102469	MFH 08-24T	24	8.0/0.315	9.30	1200	✓				✓	✓							
	102470	MFH 08-32T	32	8.0/0.315	11.85	900	✓				✓	✓							
	102471	MFH 10-18T	18	10.0/0.394	13.09	1000	✓		✓	✓		✓		✓	✓				
	102472	MFH 10-24T	24	10.0/0.394	16.89	900	✓		✓	✓		✓		✓	✓				
	110583	MFH 10-32T	32	10.0/0.394	21.94	500	✓		✓	✓		✓		✓	✓				
	151603	MFH 13-18T	18	13.0/0.512	20.56	800	✓											✓	
	151604	MFH 13-24T	24	13.0/0.512	26.31	600	✓											✓	
	4:1/10:1 MFHX 	102473	MFHX 06-18T	18	6.0/0.236	4.16	1700	✓				✓							
		102474	MFHX 06-24T	24	6.0/0.236	5.20	1400	✓				✓							
113275		MFHX 06-32T	32	6.0/0.236	6.56	1200	✓				✓								
102475		MFHX 08-18T	18	8.0/0.315	7.28	1400	✓					✓	✓						
102476		MFHX 08-24T	24	8.0/0.315	9.14	1200	✓					✓	✓						
112720		MFHX 08-32T	32	8.0/0.315	11.55	900	✓					✓	✓						
102477		MFHX 10-18T	18	10.0/0.394	12.96	1000	✓		✓	✓		✓		✓	✓				
102478		MFHX 10-24T	24	10.0/0.394	16.70	900	✓		✓	✓		✓		✓	✓				
113250		MFHX 10-32T	32	10.0/0.394	21.22	500	✓		✓	✓		✓		✓	✓				
151605		MFHX 13-18T	18	13.0/0.512	20.73	800	✓											✓	
151606		MFHX 13-24T	24	13.0/0.512	26.48	600	✓											✓	
1:1/2:1 MFQ 	116032	MFQ 05-16L	16	5.3/0.209	2.90	2500		✓											
	116033	MFQ 05-24L	24	5.3/0.209	3.52	2000		✓											
	116034	MFQ 07-24T	24	7.5/0.295	6.11	1500	✓												
	115959	MFQ 08-24T	24	8.7/0.343	8.69	750	✓											✓	
	116734	MFQ 08-32D	32	8.7/0.343	11.10	800		✓											
	116035	MFQ 10-24T	24	10.7/0.421	14.75	600	✓												
4:1/10:1 MFQX 	116036	MFQX 05-16L	16	5.3/0.209	3.07	2500		✓											
	116037	MFQX 05-24L	24	5.3/0.209	3.69	2000		✓											
	116038	MFQX 07-24T	24	7.5/0.295	6.28	1500	✓												
	116039	MFQX 08-24T	24	8.7/0.343	8.86	750	✓											✓	
	116735	MFQX 08-32D	32	8.7/0.343	11.10	800		✓											
	116044	MFQX 10-24T	24	10.7/0.421	14.92	600	✓												

MATCHING DISPENSERS

	ID	Article	Ratio				Force (kN)
			1:1	2:1	4:1	10:1	
DM2X dispenser manual 	165803	DM2X 200-01-52	✓	✓			5.2
	165804	DM2X 200-04-52			✓		5.2
	165805	DM2X 200-10-52				✓	5.2
DP2X dispenser pneumatic 	165860	DP2X 200-01-25	✓	✓			2.5
	165861	DP2X 200-04-25			✓		2.5
	165862	DP2X 200-10-25				✓	2.5
DB2K dispenser battery 	152603	DB2K 400-01-500	✓				5.0
	152605	DB2K 400-02-500		✓			5.0
	152607	DB2K 400-04-500			✓		5.0
	152609	DB2K 400-10-500				✓	5.0

DELIVERING INNOVATION. INSPIRING CONFIDENCE.

EUROPE

medmix Switzerland AG

Ruetistrasse 7

9469 Haag, Switzerland

Phone +41 81 414 70 00

sales.industry@medmix.com

www.medmix.swiss

USA, SOUTH AMERICA, CANADA AND MEXICO

medmix USA Inc.

8 Willow St.

Salem, NH 03079, USA

Phone +1 603 893 2727

sales.industry@medmix.com

www.medmix.swiss

UK AND IRELAND

medmix UK Ltd.

1 Tealgate, Charnham Park, Hungerford

Berkshire, RG17 0YT, United Kingdom

Phone: +44 (0)1488 647 800

sales.industry@medmix.com

www.coxdispensers.com

ASIA PACIFIC

medmix China Ltd.

68 Bei Dou Lu, Minhang Shanghai

200245, China

Phone: +86 21 6430 68 68

sales.industry@medmix.com

www.medmix.swiss



Legal Notice: This brochure is a general presentation. The information contained in this publication is believed to be accurate and reliable but is not to be construed as implying any warranty or guarantee of performance. We waive any liability and indemnity for effects resulting from its application. Please, contact us for a description of the warranties and guarantees offered with our products. Directions for use and safety will be given separately. All information herein is subject to change without notice.

© 2022 medmix Switzerland AG All rights reserved.

medmix is a trademark belonging to medmix AG, and MIXPAC is a trademark belonging to medmix Switzerland AG.

MIXPAC™ K-System



2-COMPONENT INDUSTRY
SOLUTIONS

 medmix

INDUSTRY





OVERVIEW

MIXPAC™ K-SYSTEM

2.5/5/10 ML INDUSTRIAL KIT

ACCESSORIES

ACCESSORIES

	ID	Article
	102267	IOR 209-20
	102272	IOT 212-20

OUTLET TIP

 Tapered Tip (S)

 Straight Tip (D)

MIXER



CARTRIDGE

3 mL



1:1

2.5 mL



1:1

5 mL



1:1

DISPENSER

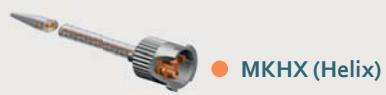

10 mL

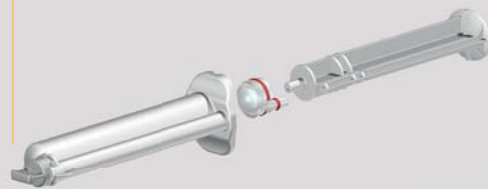

CARTRIDGE SET INDUSTRIAL KIT





CARTRIDGE ASSEMBLY 2.5–10 ML



Ratio Set/ Volume	ID	Article	Cartridges Material/Color	Plunger Color	Piston Material/Type	Units/ Box	Mixer Technology
1:1 2.5 mL	116436	KK 002-01-10-01	PP/○		HDPE, solid lip seal	2000	MKH ○
	103128	PLH 002-01-45		○		2000	
1:1 3 mL	301618	KK 003-01-10-02	PP/⊕	●	HDPE, solid lip seal integrated plunger	1800	
1:1 5 mL	116438	KK 005-01-10-01	PP/○		HDPE, solid lip seal	1500	MKH ○
	116667	KK 005-01-10-02	PP/⊕		HDPE, black, solid lip seal	1500	MKH ○
	116764	KK 005-01-10-05	PP/⊕		HDPE, solid lip seal with silicone O-ring	1500	MKH ○
	116861	KK 005-01-10-06	PP/●		Silicone, solid lip seal	1500	MKH ○
	113403	PLHX05-01-45		○		2000	
	128616	KK 005-01-10-07	PP/○	○	PP, solid lip seal integrated plunger	1500	MKH ○
1:1 10 mL	116440	KK 010-01-10-01	PP/○		HDPE, solid lip seal	500	MKH ○
	128200	KK 010-01-10-02	PP/⊕		HDPE, solid lip seal	500	MKH ○
	116763	KK 010-01-10-05	PP/⊕		HDPE, solid lip seal with silicone O-ring	500	MKH ○
	113401	PLHX10-01-45		○		1000	
4:1 10 mL	162623	KK 010-04-10-01	PP/⊕		HDPE, solid lip seal with silicone O-ring	1000	MKHX ●
10:1 10 mL	116442	KK 010-10-10-01	PP/○		HDPE, solid lip seal	500	MKHX ●
	167294	KK 010-10-20-01	PBT/○		HDPE, solid lip seal	500	MKHX ●
	113371	PLHX10-10-45		○		1000	

MATCHING MIXERS

	ID	Article	Number of Elements	Inner Diameter Ø mm/inch	Waste Volume (mL)	Units/ Box	Outlet Tip				Accessories	
							Stepped Tip (T)	Straight Tip (D)	Luer Slip Tip (L)	Tapered Tip (S)	IOT 212-20	IOR 209-20
1:1/2:1 MKH 	114252	MKH 02-08D	8	2.5/0.098	0.14	9000	✓				✓	✓
	114246	MKH 02-08S	8	2.5/0.098	0.19	9000			✓			
	114253	MKH 02-12D	12	2.5/0.098	0.23	8000	✓				✓	✓
	114249	MKH 02-12S	12	2.5/0.098	0.23	8000			✓			
	115686	MKH 02-16S	16	2.5/0.098	0.27	7000			✓			
	114254	MKH 03-12D	12	3.2/0.126	0.39	6000	✓				✓	✓
	114250	MKH 03-12S	12	3.2/0.126	0.39	6000			✓			
	114251	MKH 03-16S	16	3.2/0.126	0.49	4000			✓			
4:1/10:1 MKHX 	114260	MKHX 02-08D	8	2.5/0.098	0.19	9000	✓				✓	✓
	114255	MKHX 02-08S	8	2.5/0.098	0.19	9000			✓			
	114261	MKHX 02-12D	12	2.5/0.098	0.23	8000	✓				✓	✓
	114256	MKHX 02-12S	12	2.5/0.098	0.23	8000			✓			
	114257	MKHX 02-16S	16	2.5/0.098	0.27	7000			✓			
	114262	MKHX 03-12D	12	3.2/0.126	0.39	6000	✓				✓	✓
	114258	MKHX 03-12S	12	3.2/0.126	0.39	6000			✓			
	114259	MKHX 03-16S	16	3.2/0.126	0.49	4000			✓			

DELIVERING INNOVATION. INSPIRING CONFIDENCE.

EUROPE

medmix Switzerland AG

Ruetistrasse 7

9469 Haag, Switzerland

Phone +41 81 414 70 00

sales.industry@medmix.com

www.medmix.swiss

USA, SOUTH AMERICA, CANADA AND MEXICO

medmix USA Inc.

8 Willow St.

Salem, NH 03079, USA

Phone +1 603 893 2727

sales.industry@medmix.com

www.medmix.swiss

UK AND IRELAND

medmix UK Ltd.

1 Tealgate, Charnham Park, Hungerford

Berkshire, RG17 0YT, United Kingdom

Phone: +44 (0)1488 647 800

sales.industry@medmix.com

www.coxdispensers.com

ASIA PACIFIC

medmix China Ltd.

68 Bei Dou Lu, Minhang Shanghai

200245, China

Phone: +86 21 6430 68 68

sales.industry@medmix.com

www.medmix.swiss



Legal Notice: This brochure is a general presentation. The information contained in this publication is believed to be accurate and reliable but is not to be construed as implying any warranty or guarantee of performance. We waive any liability and indemnity for effects resulting from its application. Please, contact us for a description of the warranties and guarantees offered with our products. Directions for use and safety will be given separately. All information herein is subject to change without notice.

© 2022 medmix Switzerland AG All rights reserved.

medmix is a trademark belonging to medmix AG, and MIXPAC is a trademark belonging to medmix Switzerland AG.

MIXPAC™ Blueline



2-COMPONENT INDUSTRY
SOLUTIONS

 medmix

INDUSTRY 

OVERVIEW

MIXPAC™ BLUELINE™

400 ML INDUSTRIAL SET

ACCESSORIES

OUTLET TIP

 Stepped Tip (T)

MIXER



CARTRIDGE



DISPENSER



OUTLET TIP



V notch (V)



Threaded Tip (G)



● MBLTX

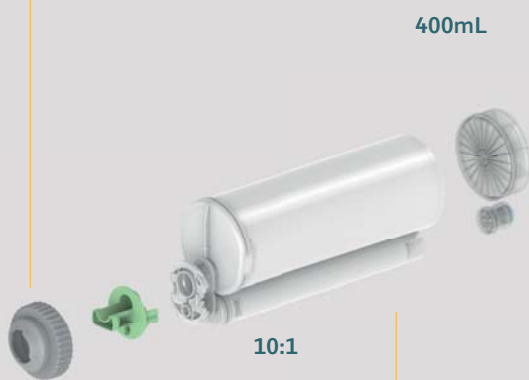

400mL

10:1



● DB2C

MIXPAC™ BLUELINE™

CARTRIDGE SET

400 INDUSTRIAL SET





CARTRIDGE ASSEMBLY 400 ML

Preassembled nose plug,
bigger outlet
Colors grey: ●





Ratio Set/ Volume	ID	Article	Cartridges Material/Color	Piston Material/Type	O-ring	Units/ Box	Mixer Technology	Matching Dispenser
2:1 400 mL	154087	ABL 400-02-10-01	PP/®	PP, self-venting	–	180	MBLT ○	DMX2 ● DPX2 ●
10:1 400 mL	154102	ABL 400-10-10-01	PP/®	PP, self-venting	–	160	MBLTX ●	DMX2 ● DPX2 ●
	167306	ABL 400-10-20-01	PBT/®	PA, self-venting		160	MBLTX ●	DMX2 ● DPX2 ●

MATCHING MIXERS

	ID	Article	Number of Elements	Inner Diameter Ø mm/inch	Waste Volume (mL)	Units/Box	Outlet Tip		
							Stepped Tip (T)	Threaded Tip (G)	V Tip (V)
2:1 MBLT 	154011	MBLT 14-12T	12	14.0/0.551	18.92	800	✓		
10:1 MBLTX 	153993	MBLTX 14-16V	16	14.0/0.551	23.48	580		✓	
	166900	MBLTX 14-16G	16	14.0/0.551	23.50	580	✓		

MATCHING DISPENSERS

	ID	Article	Ratio				Force (kN)
			1:1	2:1	4:1	10:1	
DM2X dispenser manual 	165807	DM2X 400-01-60	✓	✓			6.0
	165809	DM2X 400-10-60				✓	6.0
DP2X dispenser pneumatic 	165864	DP2X 400-01-50	✓	✓			5.0
	165866	DP2X 400-10-50				✓	5.0
ElectraFlow Dual Ultra dispenser battery 	163287	DB2C 400-MR-500-001	✓	✓	✓	✓	5.0

DELIVERING INNOVATION. INSPIRING CONFIDENCE.

EUROPE

medmix Switzerland AG

Ruetistrasse 7

9469 Haag, Switzerland

Phone +41 81 414 70 00

sales.industry@medmix.com

www.medmix.swiss

USA, SOUTH AMERICA, CANADA AND MEXICO

medmix USA Inc.

8 Willow St.

Salem, NH 03079, USA

Phone +1 603 893 2727

sales.industry@medmix.com

www.medmix.swiss

UK AND IRELAND

medmix UK Ltd.

1 Tealgate, Charnham Park, Hungerford

Berkshire, RG17 0YT, United Kingdom

Phone: +44 (0)1488 647 800

sales.industry@medmix.com

www.coxdispensers.com

ASIA PACIFIC

medmix China Ltd.

68 Bei Dou Lu, Minhang Shanghai

200245, China

Phone: +86 21 6430 68 68

sales.industry@medmix.com

www.medmix.swiss



Legal Notice: This brochure is a general presentation. The information contained in this publication is believed to be accurate and reliable but is not to be construed as implying any warranty or guarantee of performance. We waive any liability and indemnity for effects resulting from its application. Please, contact us for a description of the warranties and guarantees offered with our products. Directions for use and safety will be given separately. All information herein is subject to change without notice.

© 2022 medmix Switzerland AG All rights reserved.

medmix is a trademark belonging to medmix AG, and MIXPAC is a trademark belonging to medmix Switzerland AG.